

29.03.2017

- |                                  |                              |
|----------------------------------|------------------------------|
| (D) Montageanleitung             | (GB) Assembly Instructions   |
| (FR) Notice de montage           | (IT) Istruzioni di montaggio |
| (NL) Handleiding voor de montage | (PL) Instrukcja montażu      |
| (CZ) Montážní návod              | (SK) Návod na montáž         |
| (HU) Szerelési útmutató          | (RO) Instrucțiuni de montaj  |
| (TR) Montaj talimatı             | (RU) Инструкции по монтажу   |

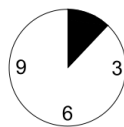

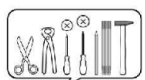

2-2,5

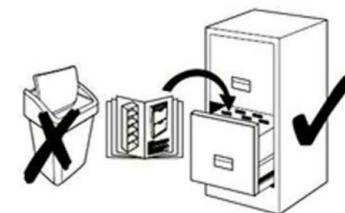
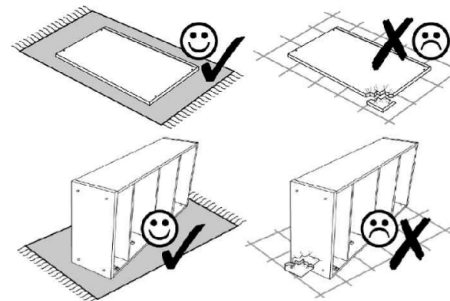
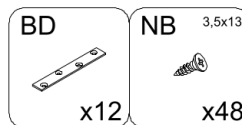
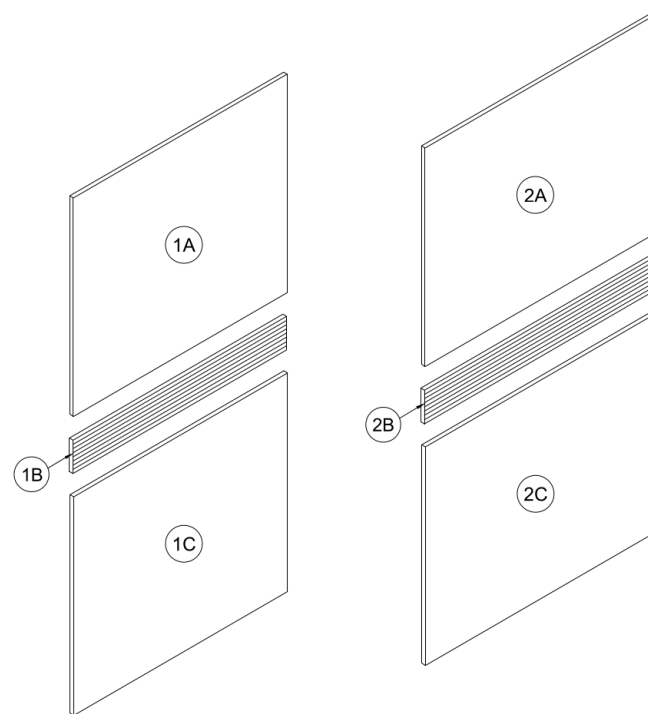
1

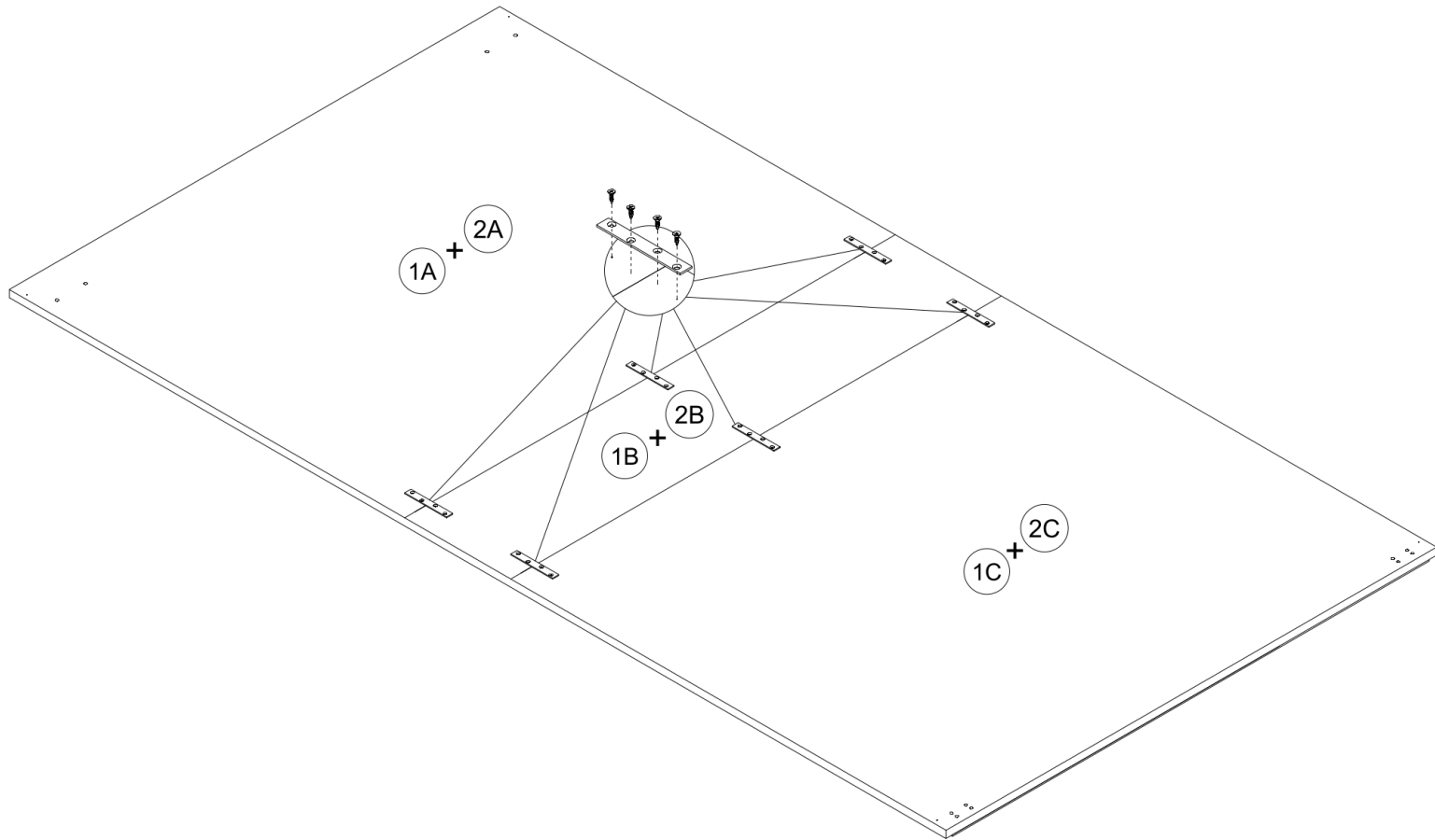

2



BD	NB 3,5x13
	
x12	x48